

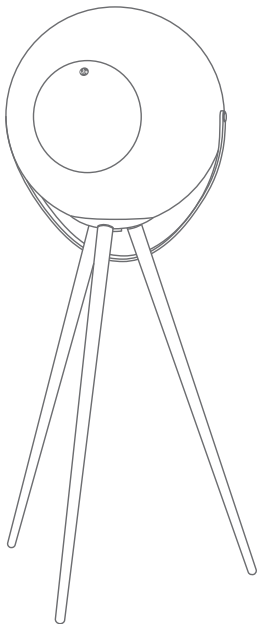

UB+
EUPHO E3
SPEAKER

USER MANUAL



CONGRATULATIONS

You are now the owner of a UB+ EUPHO E3 Speaker. The UB+ EUPHO E3 Speaker incorporates the best elements of traditional speaker design and the latest audio technology, to create a large size speaker, that is suited for wireless devices in this age of mobility.



Please contact us if you have any comments or questions.

   [ubplussg](#)

www.ub-plus.com

 **CE** **FC** **RoHS**

1 YEAR LIMITED HARDWARE WARRANTY & REGISTRATION

The warranty does not cover any damage caused by misuse or neglect.

To register your EUPHO E3 for warranty, simply scan the QR code at the back of the speaker and follow the instructions on the screen. Alternatively, you may wish to visit ub-plus.com/warranty

Please also remember to retain your proof of purchase in order for the warranty to be valid.

WHAT'S IN THE BOX

- UB+ EUPHO E3 Speaker
- Tabletop base
- Freestanding base for legs (with camera tripod mount)
- Solid wood legs x 3
- Leather strap
- Quick start guide
- USB cable and power adapter

INSTALLING THE STRAP

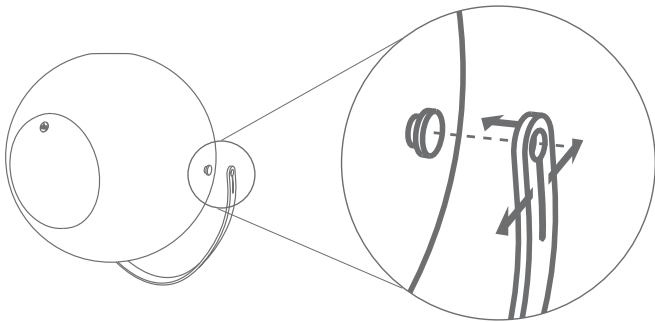

POSITIONS

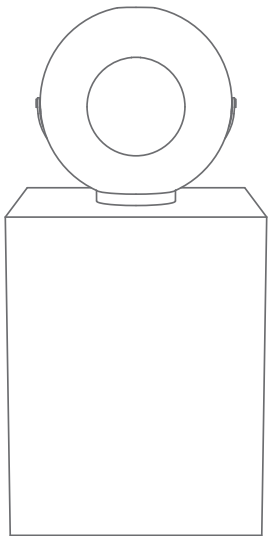

With tabletop base

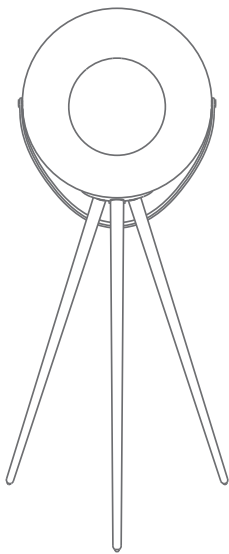

With freestanding base, attached to
wooden legs

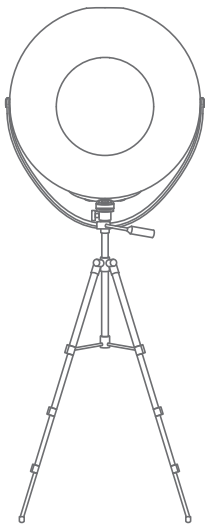

With freestanding base, attached to camera tripod (not included in package), for variable height

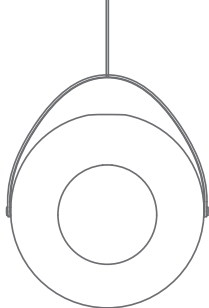

Hung up by the strap

CHARGING THE SPEAKER

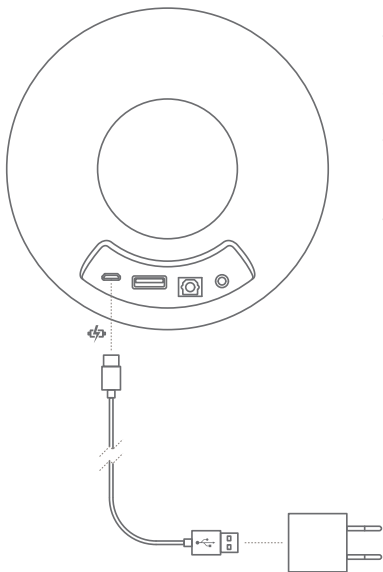

Connect the USB cable to the plug and to the micro USB port on the EUPHO E3.

When the cable is plugged in to the electricity outlet, the EUPHO E3 will start to charge as represented by the red light.

The red light will go off when charging is completed.

The EUPHO E3 goes into standby mode, as represented by the breathing Bluetooth light to conserve energy, if there is no Bluetooth connection. The EUPHO E3 shuts itself down after another 15 minutes of inactivity. During standby mode, press any button to activate the speaker.

When the battery level drops to below 10%, there will be an intermittent alert sound to indicate the low battery status.

You can find out the battery level by pressing the Power button . The battery level will be represented by the number of EQ Mode lights being lit, one light being 25% and four lights being 100%. This function is only valid when the speaker is switched on.

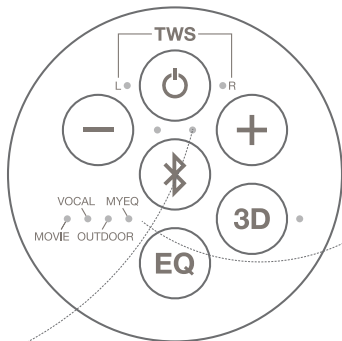

SWITCHING ON

1. Press the Power button  to turn the speaker on.

SWITCHING OFF

1. Press and hold the Power button  to turn the speaker off.

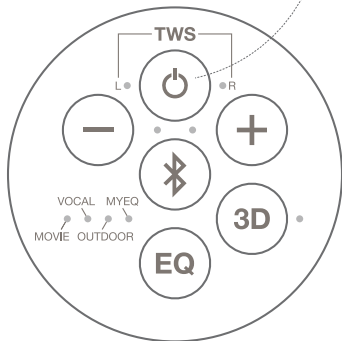

BLUETOOTH PAIRING WITH DEVICE

1. Press and hold the Bluetooth button (📶) for the speaker to enter into Bluetooth pairing mode, as represented by the blinking blue light above the Bluetooth button.
2. Turn on Bluetooth on your device and select "UB+ EUPHO E3" from the list of devices.
3. There will be a beep and the Bluetooth light will stay lit when pairing is successful.

Note: The last paired device will be connected to the speaker automatically if it is available, after the EUPHO E3 is switched on.

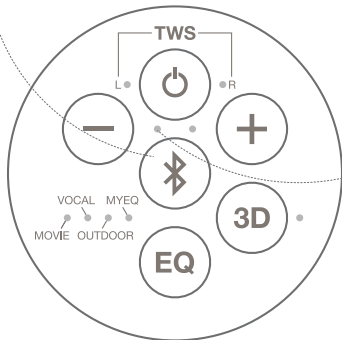

VOLUME CONTROL

Press the volume control button to adjust the volume of the speaker up or down. There will be a beep when the maximum volume is reached.

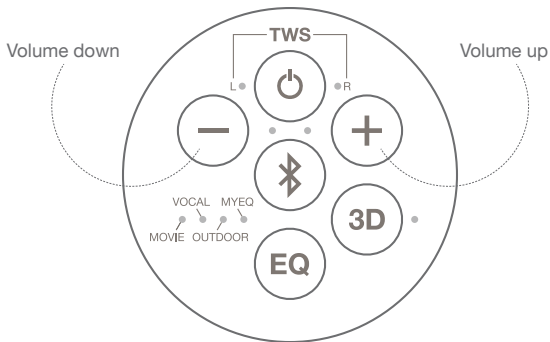

PLAYING MEDIA

Media can be played or paused by pressing the Bluetooth button  .

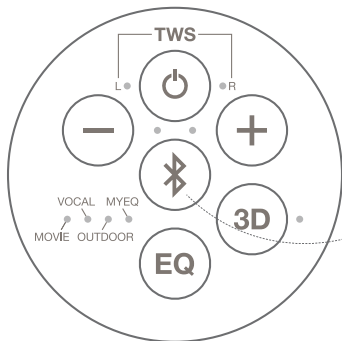

SPEAKERPHONE

When the EUPHO E3 is connected to your phone via Bluetooth, it can act as a speakerphone. You can press the Bluetooth button to accept the call or press and hold the Bluetooth button for 3 seconds to reject the call, when a call comes in.

3D MODE

Press the 3D button to turn the 3D Mode on or off. The 3D Mode light is lit when 3D mode is switched on.

The 3D Mode, in conjunction with the EQ Modes, allows the EUPHO E3 to be flexible and adapt to your needs.

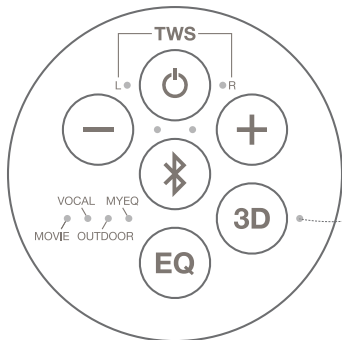

ADJUSTING EQ

The EUPHO E3 comes with three preset EQ modes - MOVIE, VOCAL, OUTDOOR and MYEQ. MYEQ, give the true original sound from the source.

The EUPHO E3 is in Default mode when first switched on. Press the EQ button to toggle between the different modes, as represented by the respective EQ Mode lights. When no EQ light is lit, the EUPHO E3 is in Default mode:

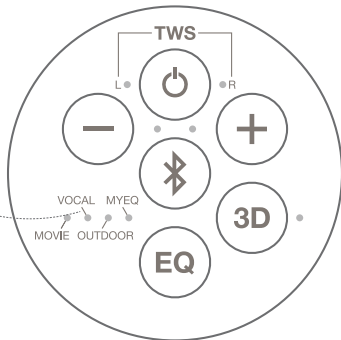

TRUE WIRELESS STEREO (TWS) PAIRING BETWEEN TWO EUPHO E3 SPEAKERS

1. Press and hold both the Volume \ominus down button and the Volume up button \oplus together and the speaker will go into TWS pairing mode.
2. Both speakers would be paired automatically to each other if there are in proximity to each other.
3. To toggle the channels between the speakers, press both the Volume up and Volume down buttons together.
4. When connect to optical Input, TWS will not be supported.
5. Pirority given to 3.5mm Jack connection even when device are connected via BT connection.

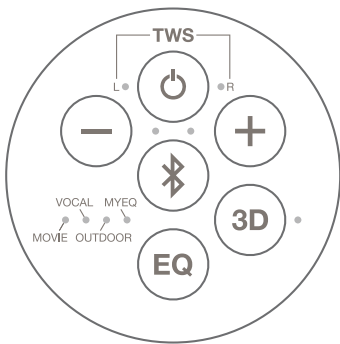

OTHER INPUTS

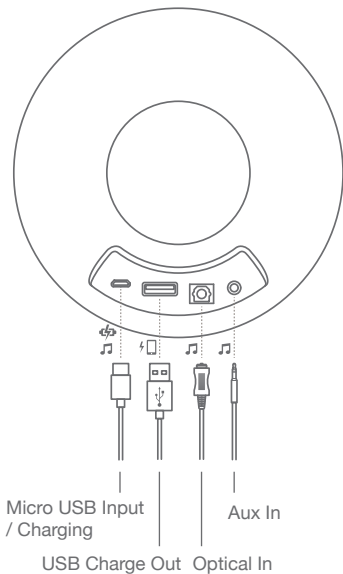

Other than Bluetooth, there are other inputs that can work with the EUPHO E3. Note: Cables are not included in this package.

The inputs are prioritised in this order - Bluetooth, USB and then optical.

The 3.5mm auxillary input will override the rest of the inputs when the aux cable is plugged into the speaker. The speaker will restart when the cable is plugged out.

This ensures that the EUPHO E3 can be safely used as a microphone or instrument speaker with no potential interruption from other sources.

SPECIFICATIONS

Driver: 6.5" full range

Output: 25 W

Sensitivity: 100 dB

Amplifier: 60 W

Frequency response: 35 Hz - 17 kHz

Impedance: 4 Ohms

Battery capacity: 4400 mAh @ 7.4V DC

Battery charging voltage: 5 V (USB)

Inputs: Bluetooth, USB digital, 3.5 analogue, optical

Bluetooth: Stereo, TWS, aptX

Dimensions: W375 x D355 x H357 mm

Enclosure diameter: 360 mm

Weight: 1.5 kg

Height (mounted on tabletop base): 360 mm

Height (mounted on legs): 974 mm