



UB+
EUPHO E3
SPEAKER

QUICK START GUIDE

CONGRATULATIONS

You are now the owner of a UB+ EUPHO E3 Speaker. The UB+ EUPHO E3 Speaker incorporates the best elements of traditional speaker design and the latest audio technology, to create a large size speaker, that is suited for wireless devices in this age of mobility.

This quick guide is meant to be a simple introduction to the usage of the speaker. The full manual can be downloaded from the UB+ website (ub-plus.com/images/Files/EUPHO_E3-User_Manual.pdf) or by scanning the QR code below.



Please contact us if you have any comments or questions.

   [ubplussg](https://www.facebook.com/ubplussg)
www.ub-plus.com
www.ub-plus.fr

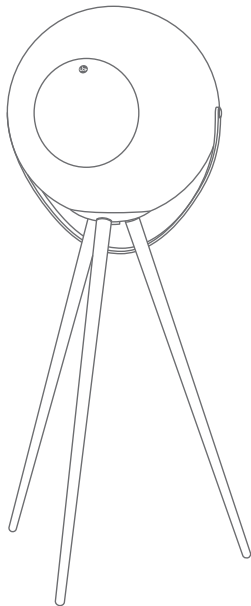

CONTROLS



Qx1

Power on
Check battery level*

Q3s

Power off



Q3s

Bluetooth pairing mode

Qx1

Play/Pause
Pick up incoming call

Qx1

Volume down

Qx1

Volume up

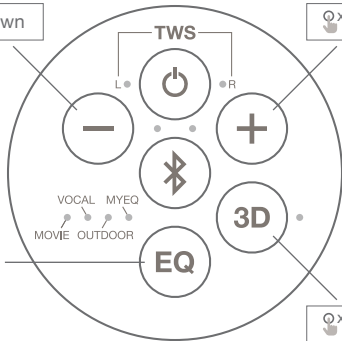

Qx1

Toggle
between
EQ
modes

Qx1

3D mode on/off



Q Q3s

TWS pairing mode

Q Qx1

Toggle between TWS modes
(L/R, R/L, Mono)

* only when speaker is switched on

BASIC FUNCTIONS

SWITCHING ON AND OFF



1. Press the Power button  to turn the speaker on.
2. Press and hold the Power button to turn the speaker off.

BLUETOOTH PAIRING WITH DEVICE

1. Press and hold the Bluetooth button  for the speaker to enter into Bluetooth pairing mode, as represented by the blinking blue light above the Bluetooth button.
2. Turn on Bluetooth on your device and select "UB+ EUPHO E3" from the list of devices.
3. There will be a beep and the Bluetooth light will stay lit when pairing is successful.

Note: The last paired device will be connected to the speaker automatically if it is available, after the EUPHO E3 is switched on.

TRUE WIRELESS STEREO (TWS) PAIRING BETWEEN TWO EUPHO E3 SPEAKERS

1. Press and hold both the Volume down button  and the Volume up button  together and the speaker will go into TWS pairing mode.
2. Both speakers would be paired automatically to each other if there are in proximity to each other.
3. To toggle the channels between the speakers, press both the Volume up and Volume down buttons together.
4. When connect to optical Input, TWS will not be supported.
5. Pirority given to 3.5mm Jack connection even when device are connected via BT connection.

PORTS

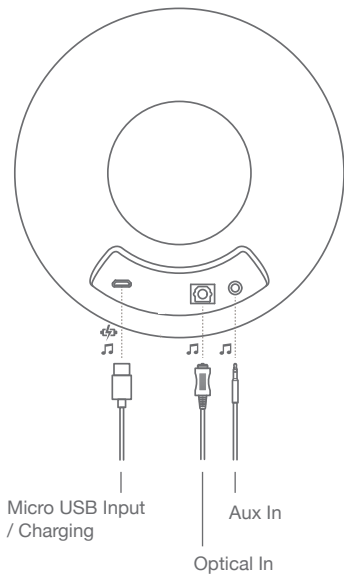

STRAP

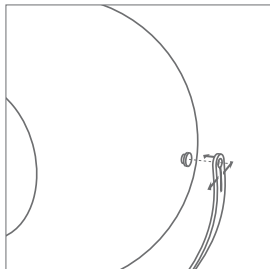

POSITIONS

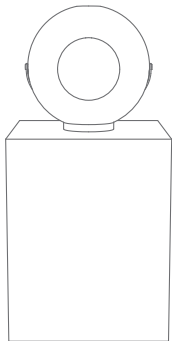

With tabletop
base

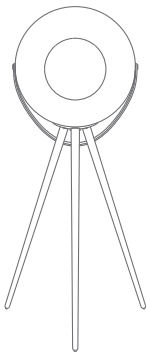

With freestanding
base, attached to
wooden legs



With freestanding
base, attached to
camera tripod

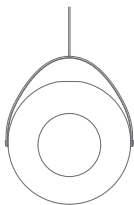

Hung up by the
strap

WHAT'S IN THE BOX

- UB+ EUPHO E3 Speaker
- Tabletop base
- Freestanding base for legs (with camera tripod mount)
- Solid wood legs x 3
- Leather strap
- Quick start guide

FEDERAL COMMUNICATIONS COMMISSION REGULATORY INFORMATION (FCC)

This device complies with Part 15 of the FCC Rules. Operation is subject to the following two conditions:(1) this device may not cause harmful interference, and (2) this device must accept any interference received, including interference that may cause undesired operation.

NOTE: This equipment has been tested and found to comply with the limits for a Class B digital device, pursuant to part 15 of the FCC Rules. These limits are designed to provide reasonable protection against harmful interference in a residential installation.

This equipment generates uses and can radiate radio frequency energy and, if not installed and used in accordance with the instructions, may cause harmful interference to radio communications. However, there is no guarantee that interference will not occur in a particular installation.

If this equipment does cause harmful interference to radio or television reception, which can be determined by turning the equipment off and on, the user is encouraged to try to correct the interference by one or more of the following measures:

- Reorient or relocate the receiving antenna.
- Increase the separation between the equipment and receiver.
- Connect the equipment into an outlet on a circuit different from that to which the receiver is connected.
- Consult the dealer or an experienced radio/TV technician for help.

Changes or modifications not expressly approved by the party responsible for compliance could void the user's authority to operate the equipment.



ub-plus.com
ub-plus.fr